

ESD Transport Trolleys

Innovative, individual, ESD-compliant



ESD Transport Trolleys

The body scores with a robust frame made of aluminum cavity profiles and black, conductive ABS plastic molded parts, manufactured in Germany. The Maxi FLEX is stopped by two ESD swivel castors with brakes.

Type 700 Maxi FLEX



Aluminum cavity profile supporting surface 50 mm/frame height 20 mm

The frame profile encloses the external edge of the container for a safe, slip-resistant stand during transport.

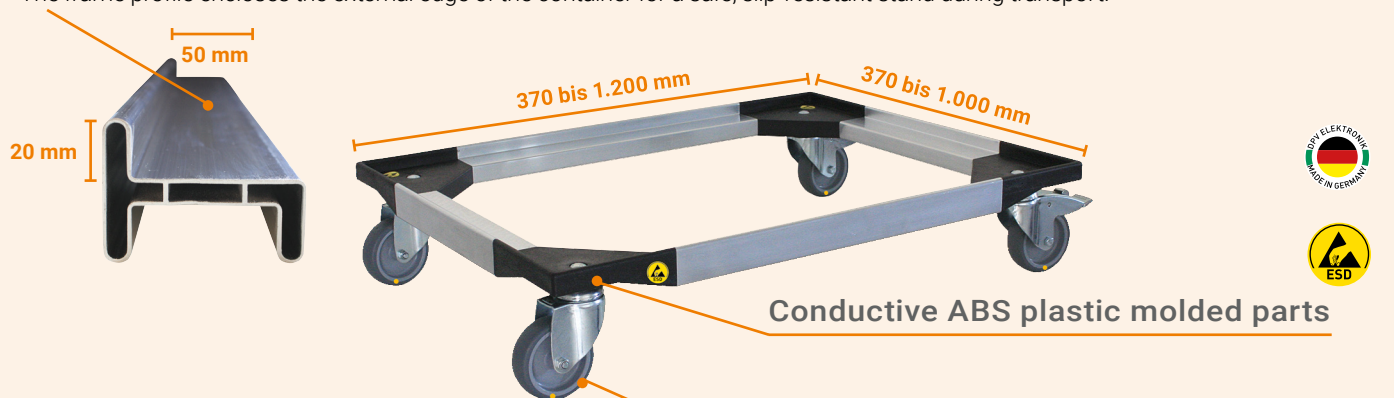

Conductive ABS plastic molded parts

Loadable construction up to 200 kg



Payload/surface load: max. 200 kg (with evenly distributed load)

Non-marking ESD conductive swivel castors

- 2x with locks

Type 700 Maxi FLEX standard

The innovative Maxi FLEX transport trolley of the EPAmove[®] series by DPV is lightweight and at the same time very resilient. With its maximum flexibility due to different sizes, it remains safe and stable when transporting e.g. Euro containers, magazines and pallets.

- Robust frame made of heat-hardened aluminum cavity profile
- Black conductive ABS plastic corner parts
- Loadable up to 200 kg, even distribution of the load
- Low dead weight (from approx. 4 kg)
- 4 non-marking ESD swivel castors (2x with lock)
- Supporting surface 50 mm
- Frame height 20 mm
- Suitable for various standard containers from stock:
 - 600 x 400 mm / 700 x 400 mm / 800 x 400 mm
 - 800 x 600 mm
 - 1200 x 800 mm



dpvlink 17882

For more information, see compumet.ch. Simply enter the number of the green **dpvlink** in the search box.



Individual Solutions

Adapted to your requirements – individual dimensions are possible for the Maxi Flex transport trolley of the EPAmove[®] series. With a successful combination of form and function, the EPAmove[®] transport trolley type 700 Maxi FLEX convinces.

Thanks to the innovative modular system, we can offer you sizes with internal support dimensions from 370 x 370 mm to 1,200 x 1,000 mm, suitable for your containers, magazines and pallets.

[to the configurator for transport trolleys](#)

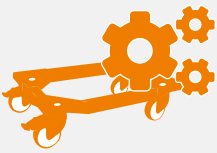

Scan the QR code and use our online configurator to create your desired product conveniently.



Picture shows
ESD Shelf Trolley (from page 6)

ESD Transport Trolleys

Type 101 + type 100

- Suitable for Euro, transport containers and PCB magazines
- Galvanized metal construction
- Special sizes on request
- 4 swivel castors, solid rubber, black or grey (non-marking), conductive, Ø 100 mm, smooth rolling, load capacity 150 – 200 kg
- Trolley non-marking / ELS version: wheel body made of polypropylene, equipped with thermoplastic, non-marking rubber tread, electrically conductive



dpvlink 18028 / dpvlink 1906

All sizes can be found at compumet.ch. Simply enter the number of the green **dpvlink** in the search box.



ESD Transport Trolleys

Type 500 ABS

- Very durable plastic frame
- Thermoplastic wheels

Type 500 includes the outer edges of the container



of conductive ABS	Type 500 ABS	Type 501 ABS	Type 510 ABS	Type 511 ABS
dpvlink	6790			
Article number	5391.500	5391.501	5391.510	5391.511
External dimensions	620 x 420 x 140 mm		620 x 420 x 175 mm	
Frame internal dimensions	605 x 405 x 20 mm			
4 swivel castors	✓	✓	✓	✓
Castors addition	non-marking	non-marking, 2x locks	non-marking	non-marking, 2x locks
Wheel diameter	75 mm		100 mm	
Pay load	200 kg		250 kg	
For standard Euro containers 600 x 400 mm / 400 x 300 mm	✓	✓	✓	✓

Accessories

Our ESD transport trolley accessories include various components and accessories that have been specially developed for use in ESD-protected areas. It is important that the accessory complies with ESD protection requirements and is certified accordingly to ensure the safety of sensitive electronic parts and components during transport.

Stacking trolleys ESD (up to 15 transport trolleys)



Article:
5391.536 (for Type 500)
dpvlink 6790
5391.636 (for Type 600)
dpvlink 17478

Pull rods (galvanized)



Article:
5391.535.ZS5
dpvlink 1909

Type 600 ABS

- First-class, maintenance-free wheel equipment (series 600)
- Very durable plastic frame
- Thermoplastic wheels

Type 600 includes the container stacking edges



Type 600 ABS	Type 601 ABS	Type 610 ABS	Type 611 ABS
17478			
5391.600	5391.601	5391.610	5391.611
581 x 381 x 131 mm		581 x 379 x 158 mm	
572 x 372 x 20 mm			
✓	✓	✓	✓
-	2x locks	-	2x locks
75 mm		100 mm	
200 kg			
✓	✓	✓	✓

ESD Shelf trolleys

The robust and durable DPV shelf trolleys of the EPAmove[®] series fit perfectly into any production. Height-adjustable shelves and tiltable shelves make it possible to adapt to many applications at any time. The DPV shelf trolleys are available in various dimensions and heights.

In compliance with the ESD standard DIN EN 61340-5-1



- Robust metal construction (galvanized) with 2 handles
- Robust base frame
- 4 shelves
- 4 swivel castors, 2x with locks made of black solid rubber
- ELS version with grey, non-marking ESD swivel castors
- Payload up to 250 kg
- Payload per shelf up to 80 kg
- Shelves adjustable in height (25 mm spacing) and inclination (except type 1207 and type 1208 – bottom shelf permanently installed)
- Easy self-assembly



Type 1207
height 1286 mm

Type 1208
height 1750 mm

Type 1213
height 1310 mm

Type 1214
height 1780 mm

Type 1217
height 1310 mm

Type 1218
height 1780 mm

Versions

ESD shelf trolleys	Type 1207	Type 1207 ELS	Type 1208	Type 1208 ELS	Type 1213	Type 1213 ELS
dpvlink	1207	1207 ELS	1208	1208 ELS	1213	1213 ELS
Article number	5390.1207	5390.1207.ELS	5390.1208	5390.1208.ELS	5390.1213	5390.1213.ELS
External dimensions	770 x 540 x 1286 mm		770 x 540 x 1750 mm		990 x 660 x 1310 mm	
Internal dimensions shelves	610 x 405 mm				830 x 610 mm	
Internal dimensions bottom shelf	625 x 490 mm				830 x 610 mm	
4 swivel castors	✓	✓	✓	✓	✓	✓
Castors addition	2x locks, solid rubber standard	2x locks, non-marking grey	2x locks, solid rubber standard	2x locks, non-marking grey	2x locks, solid rubber standard	2x locks, non-marking grey
4 shelves	✓	✓	✓	✓	✓	✓
Shelves adjustable	✓	✓	✓	✓	✓	✓
Wheel diameter	100 mm				125 mm	

ESD Transport Trolleys

- Suitable for Euro containers 600 x 400 mm and 400 x 300 mm
- Galvanized metal bracket construction
- Adjustable/tiltable
- ESD swivel castors, conductive, Ø 75 mm, smooth rolling (2x with locks)
- Load capacity up to 150 kg
- Trolley non-marking / ELS: wheel body made of polypropylene, equipped with thermoplastic, non-marking rubber tread



Article numbers:



Configurator for Transport Trolley Coverings

Configure your slip-resistant ESD coverings. In order to dissipate electrostatic charges, the coverings must be equipped accordingly – for this purpose, the coverings are connected in accordance with ESD requirements by means of a push button.























Scan the QR code and use our online configurator to create your desired covering conveniently.



Type 1214	Type 1214 ELS	Type 1217	Type 1217 ELS	Type 1218	Type 1218 ELS
1214	1214 ELS	1217	1217 ELS	1218	1218 ELS
5390.1214	5390.1214.ELS	5390.1217	5390.1217.ELS	5390.1218	5390.1218.ELS
990 x 660 x 1780 mm		1150 x 570 x 1310 mm		1150 x 570 x 1780 mm	
830 x 610 mm		990 x 430 mm			
830 x 610 mm		990 x 520 mm			
✓	✓	✓	✓	✓	✓
2x locks, solid rubber standard	2x locks, non-marking grey	2x locks, solid rubber standard	2x locks, non-marking grey	2x locks, solid rubber standard	2x locks, non-marking grey
✓	✓	✓	✓	✓	✓
✓	✓	✓	✓	✓	✓
125 mm					

Your System Supplier for Electronics Manufacturing

ESD Management	
ESD Footwear	
ESD Clothes	
Cleanroom	
ESD Protection	
Measurement and tests	
ESD Chairs	
ESD Workplace systems	
ESD Packaging	
ESD Storage and transport	
Tools	
PCB processing	
Component processing	
Mounting accessories	
Dispensing equipment	
Workstation lighting	
Optical inspection systems	
Cleaning	
Chemistry	
Soldering technology	

Compumet AG
Theodorshofweg 22
4310 Rheinfelden, Switzerland

Phone: +41 (0)61 836 10 50
E-Mail: info@compumet.ch
Internet: www.compumet.ch

Your contact:

SWITZERLAND | LIECHTENSTEIN

Compumet AG

Phone: +41 (0)61 836 10 50
E-Mail: info@compumet.ch

EUROPE | INTERNATIONAL

DPV Elektronik-Service GmbH

Herregrundstr. 1
75031 Eppingen, Germany

Phone: +49 (0)7262 9163-200
E-Mail: export@dpv-elektronik.de
Internet: www.dpv-elektronik.com



Explore our
product range online:
www.compumet.ch